

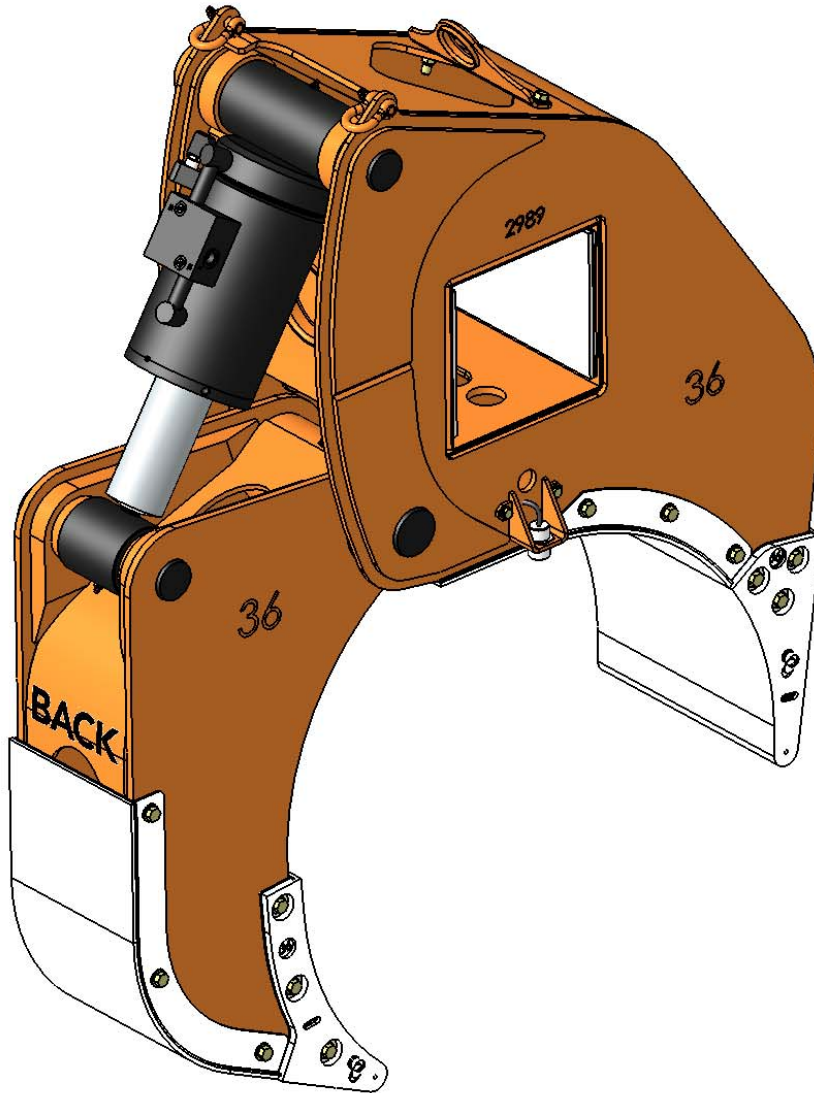

LaValley Industries



DECKHAND "XL" PIPE ARM

36 INCH PAXL SPECIFICATIONS

PART NUMBER	3209
MODEL NUMBER	PAXL 36
MAIN BEAM SIZE (INCHES)	10X10
CAPACITY	28,000 LBS/ 12,700 KG
WEIGHT	1,300 LBS/ 590 KG
SHIPPING CRATE P/N	2628
SHIPPING DIMENSION (INCHES)	66L X 46W X 70H
SHIPPING WEIGHT(ARM SET W/ CRATE)	3,725 LBS / 1,690 KG